

Data Sheet

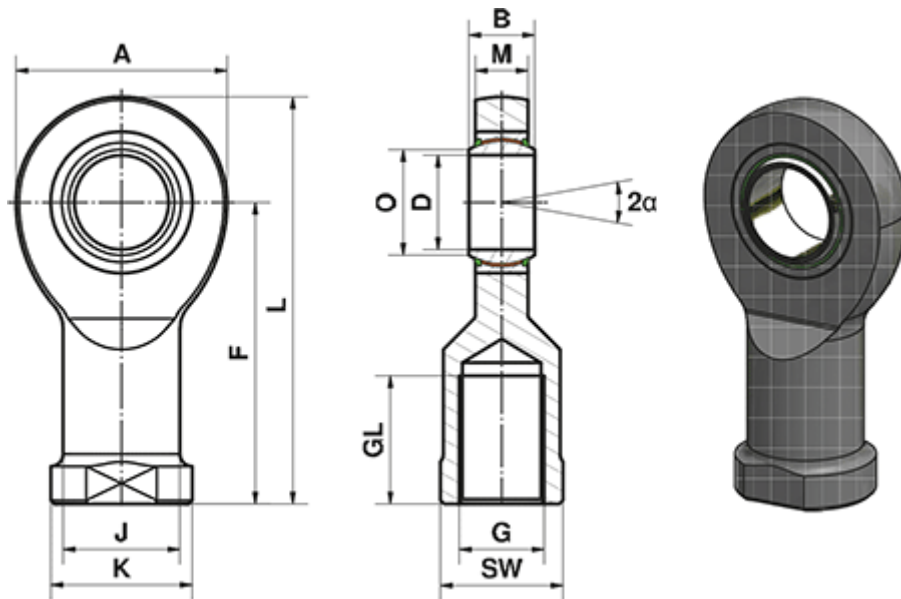

Article number: 03490040
Description: Fluro Heavy Duty Rod end EI 40 EW-2RS
M39x3 Female thread
Note: 40

Measures



A	= 92	J	= 52
a (degrees)	= 7	K	= 65
B	= 28	L	= 188
D	= 40	M	= 23
Dynamic load C (kN)	= 277	O	= 45
F	= 142	Static load C0 (kN)	= 178
G	= M39x3	SW	= 55
GL	= 65	Weight (g)	= 2000